

D2000

Bidirection Programmable DC Power Supply





Introduction

01



Highlights

02



Product Portfolio

03



Solutions

04



Our Clients

05



Introduction

01



Highlights

02



Product Portfolio

03



Solutions

04



Our Clients

05

Introduction-D2000

MORE PRECISE AND CONVENIENT

What is D2000?

1. The D2000 series is a bidirectional programmable DC power supply.
2. The D2000 series adopts SiC design of the third-generation wide band gap semiconductor devices.
3. The D2000 series is an upgraded version of the D1000 series.

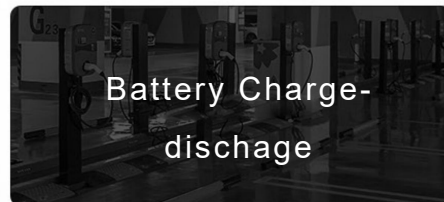



Introduction

01



Highlights

02



Product Portfolio

03



Solutions

04



Our Clients

05

Ultra High Power Density

Maximum power density of 176kW/m³+ for a single device,

Up by 112% from industrial frequency(IF) solutions

Get 300kW in a cabinet lighter than 900kg,

Down by 61.9% from industrial frequency solutions

The dimension of 300kW is 850*1000*2000(W*D*H, mm).

Down by 47% from industrial frequency solutions

Max. power density for a single device

Up by 112%



D2000



IF solutions

Weight (cabinet solutions)

Down by 61.9%

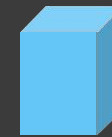

D2000



IF solutions



Modularized Design

Users can replace faulty modules on their own, no need of returning the equipment to factory.

Remove faulty modules and the equipment will run normally, avoiding affecting test efficiency



Human-machine Interaction

Self-developed 7-inch² TFT touch screen, smooth operation

Electrically-operated Switch

Push to power up, safe and convenient

Upgraded Casters

360°, move the cabinet with less effort



Efficient & Energy-saving

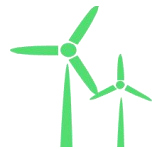
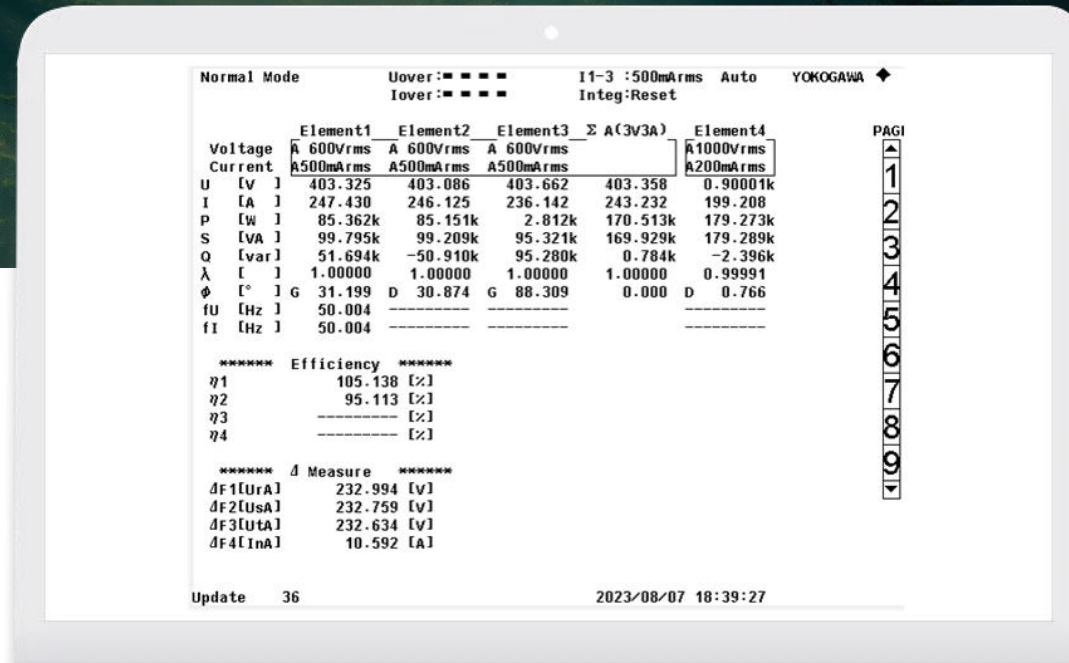

Efficiency
95.5%

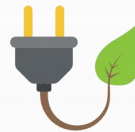

Test Duration
8H*30D*12M



Reduce CO₂ Emissions by
30150kg



Introduction

01



Highlights

02



Product Portfolio

03



Solutions

04



Our Clients

05

Product Spectrum

D2000-EV

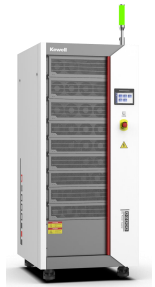

Motor controller testing

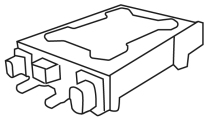

D2000-IV

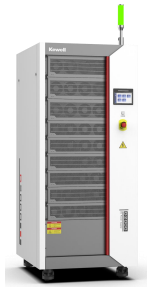

PV inverter & PCS testing

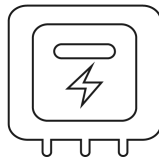

MORE PRECISE AND CONVENIENT

	Power/kW	Voltage/V	Current/A
EV	100-600	12~1200	0~1200
IV	100-600	12~2000	0~900





NORMAL

Fundamental, Cost-effective

PRO

Fully-featured, Multi-scenario



ULTRA

Ultimate experience, Lab testing-oriented



Introduction

01



Highlights

02



Product Portfolio

03



Solutions

04



Our Clients

05

D2000-EV

MORE PRECISE AND CONVENIENT

D2000-EV Series				
	Version	Normal	Pro	Ultra
Voltage	12-1200V	•	•	•
Power/Current	100kW / 300A	•	•	-
	200kW / 600A	•	•	•
	300kW / 900A	•	•	•
	400kW / 1200A	•	•	•
	500kW / 1200A	•	•	•
	600kW / 1200A	-	•	•
Functions	Bidirectional DC source	•	•	•
	Battery simulation	•	•	•
	Electronic load	-	•	•
	Electrically operated switch	-	•	•
	Manual switch	•	-	-
	Communication interfaces RS485/LAN/CAN	•	•	•
Output parameters	Voltage accuracy	±0.05%F.S.	±0.05%F.S.	±0.02%F.S.
	Current accuracy	±0.1%F.S.	±0.05%F.S.	±0.02%F.S.
	Response time*1	2ms	1ms	500us
	Switching time	4ms	2ms	1ms
	Voltage slew rate	100V/ms	200V/ms	300V/ms
	Current slew rate	200A/ms	300A/ms	500A/ms
	Voltage ripple	≤0.1%·F.S.		
	Current ripple	≤0.1%·F.S.		



Introduction-D2000

MORE PRECISE AND CONVENIENT



Super Fast Voltage Slew Rate

Voltage slew rate $\geq 300\text{V/ms}$

Load Dump Test

Meeting the load dump test requirement of 250V/ms in **LV123/**
VW80300

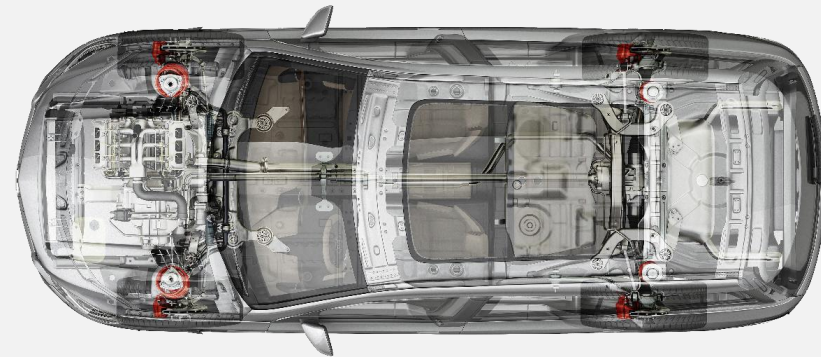

Load Dump Test

Meeting the load dump test requirement of 250V/ms in
LV123/ VW80303

6.3.5.3 Load dump and voltage limiting (LV123-255)

- LV123-256 For testing, see Section "Test: Load dump and voltage limiting"
- LV123-257 The following event is designated as load dump:
An HV component feeds electric energy into the DC HV circuit, and the maximum load is switched off under abnormal operational conditions at the same time. In this case, the switch-off under abnormal operational conditions is caused by the load current consuming HV components, e.g. switching off the switching equipment of the HV battery in charging operation.
- LV123-258 HV components shall meet the HV operating status B3 or B4 in accordance with Table "HV operating status" in the event of overvoltage due to load dump. See OEM's requirements documentation for information on the HV operating status.
- LV123-1578 HV components shall be designed for the maximum voltage dynamics in accordance with Table "Maximum voltage dynamics" in the event of overvoltage due to load dump.
- LV123-1579 Table: Maximum voltage dynamics
- LV123-1580

Parameter	HV operating status	Unit	HV_1	HV_2a	HV_2b	HV_3
Maximum voltage dynamics (slope), load dump	B3	V/ms	+/- 250	+/- 250	+/- 250	+/- 250

VOLKSWAGEN
AKTIENGESELLSCHAFT

Group standard

VW 80303
Issue 2014-06

Class No.: BMA00
Descriptors: electric vehicle, electric drive, electronic component, component, LV 123

Electrical Characteristics and Electrical Safety of High-Voltage Components in Road Vehicles
Requirements and Tests

Preface
Additional note for Porsche AG:
Volkswagen standard VW 80303 supersedes Porsche standard PN 14709¹⁾, issue 2010-04.
Earlier issues of PN 14709: 2010-04

Previous issues
VW 80303: 2010-02

Changes
The following changes have been made to VW 80303: 2010-02:
- Transfer of updated Supply Specification LV 123 to VW 80303

¹⁾ PN 14709 = VW 96088

Page 1 of 1. Continued on 163 pages Supply Specification LV 123

Always use the latest version of this standard.
The electronically generated standard is authentic and valid without signature.
The English translation is believed to be accurate. In case of discrepancies, the German version is always authoritative and controlling.

Technical responsibility

VEE-B4 Marco Thömmes Tel.: +49 841 89-575023
EEE Andreas Otmer Tel.: +49 5361 9-17670
EEE1 Dr. Marian Mazurek Tel.: +49 711 911-85654

The Standards department

WEZ-D Dr. Bernhard Angemaler
Tel.: +49 841 89-30965

All rights reserved. No part of this document may be printed or reproduced without the prior consent of one of the Volkswagen Group's Standards departments.
© Volkswagen Aktiengesellschaft

QUELLE: NOLIS

High Dynamic Response

Microsecond recovery from sudden loading

Ultra Low Drop

0-90%I@10ms, drop < 10V



Introduction-D2000

MORE PRECISE AND CONVENIENT

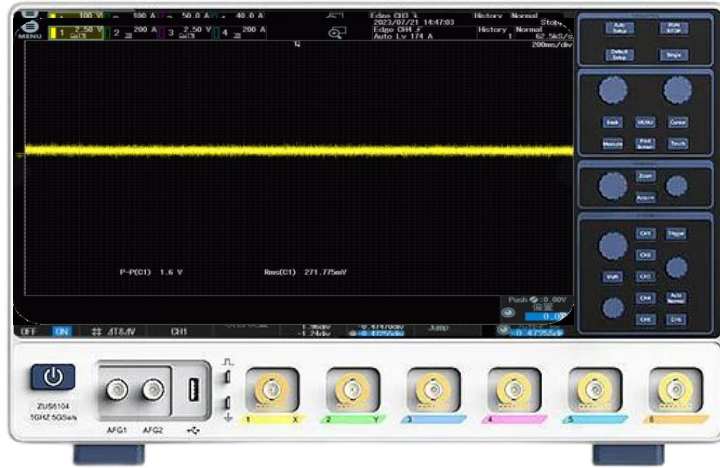

Ultra Low Ripple

Voltage and current ripple $\leq 0.1\% \cdot \text{F.S.}$

Ultra High Accuracy

Voltage and current accuracy $\pm 0.02\% \text{F.S.}$

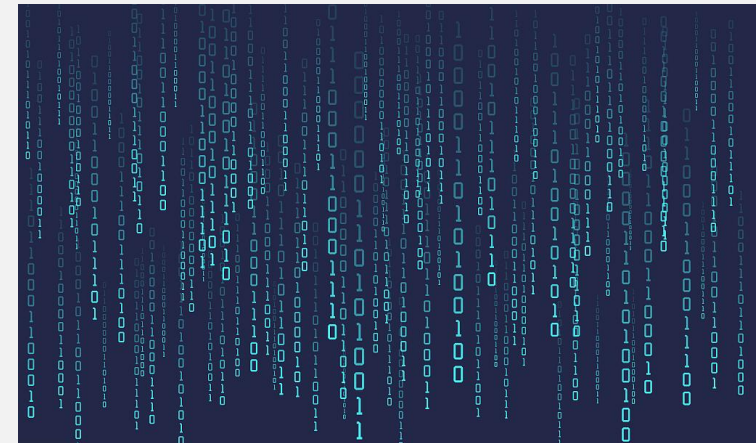

Multifaceted Functional Configurations

Battery simulator, DC source, DC electronic load, etc.



DC source



Battery simulation



Regenerative DC load

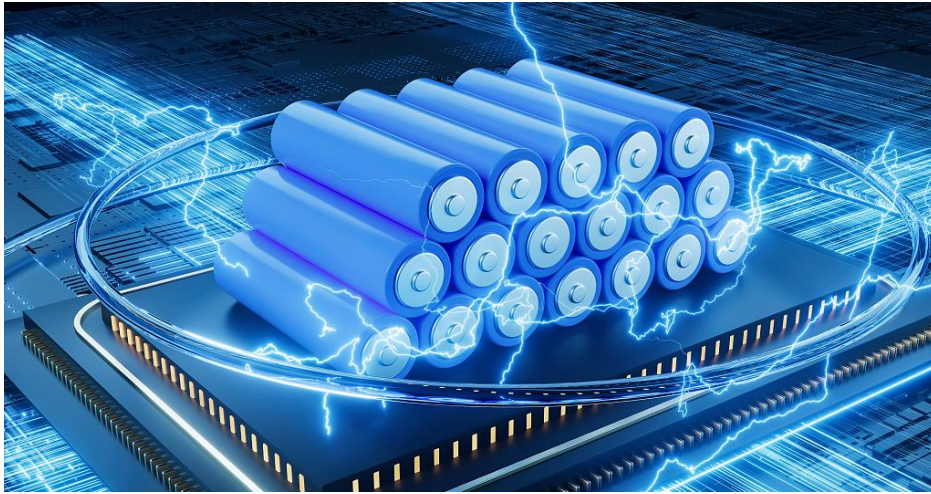

True Battery Output

Customer-defined parameters for LiFePO_4 , LiMn_2O_4 , LiCoO_2 , Ni-MH, NCM lithium, $\text{Li}_4\text{Ti}_5\text{O}$ and flow battery

1st/2nd/3rd-order Battery Models

Equivalent circuit models of 1st/2nd/3rd-order battery to accurately simulate battery behavior

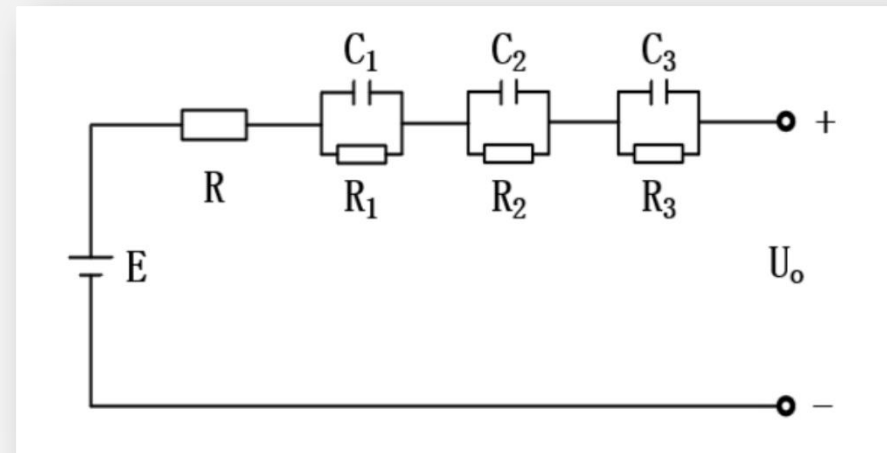

Typical Applications—Motor Controller Testing

MORE PRECISE AND CONVENIENT



The vehicle accelerates, the output current of battery increases, the power consumption increases, and the instantaneous power consumption is positive, i.e., battery discharging.



EV kinetic energy recovery ON, the power is negative during deceleration, the instantaneous power consumption is also negative, i.e., battery charging.



Motor
Traction battery
Motor controller

Laboratories

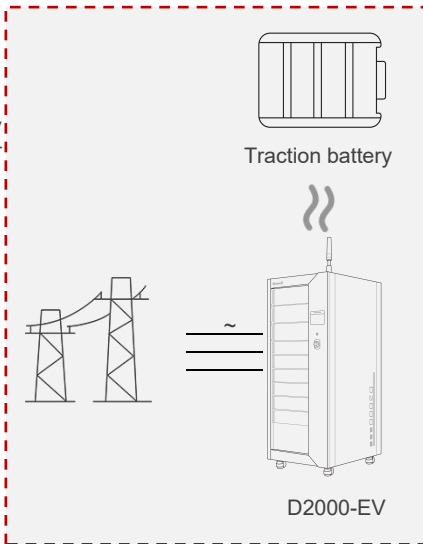

Discharge
Charge

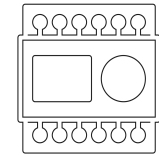

Motor controller

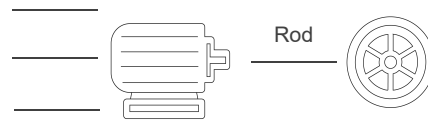

Motor

Battery simulation function

1. Simulate the actual operation of EV, acceleration being an energy output process;
2. Deceleration is a process of traction battery output and energy recovery;
3. Common types of traction battery for vehicles include LiFePO4 and Li(NiCoMn)O2 batteries, and we can simulate their output behavior.



Uniform speed to acceleration



Uniform speed to deceleration

D2000-IV

MORE PRECISE AND CONVENIENT

D2000-IV Series					
	Version	Normal	Pro	Ultra	
Voltage	12-1200V	20-2000V	•	•	•
Power / Current	100kW / 300A	–	•	•	–
	200kW / 600A	–	•	•	–
	–	100kW / 150A	•	•	•
	–	200kW / 300A	•	•	•
	–	300kW / 450A	•	•	•
	–	400kW / 600A	•	•	•
	–	500kW / 750A	•	•	•
	–	600kW / 900A	•	•	•
Output parameters	Voltage accuracy		±0.05%F.S.	±0.05%F.S.	±0.02%F.S.
	Current accuracy		±0.1%F.S.	±0.05%F.S.	±0.02%F.S.
	Response time		1ms	1ms	500us
	Switching time		2ms	2ms	1ms
	Voltage slew rate		100V/ms	200V/ms	300V/ms
	Voltage ripple		≤0.1%·F.S.		
	Current ripple		≤0.1%·F.S.		
	Efficiency		95.5%		
	Grounding resistance		≤0.1Ω		
Functions	IV simulation		•	•	•
	Bidirectional DC source		•	•	•
	Battery simulation		•	•	•
	Electronic load		•	•	•
	Electrically operated switch		–	•	•
	Manual switch		•	–	–
	Communication interfaces RS485/LAN/CAN		•	•	•



True Output Characteristics

Simulation of various PV battery types and multiple scenarios



Polycrystalline,
monocrystalline, thin film



Light, temperature, irradiance



Shading



Time scaling

Multi-step IV

Support multi-step curve editing and cycle setup, simulate PV output changes

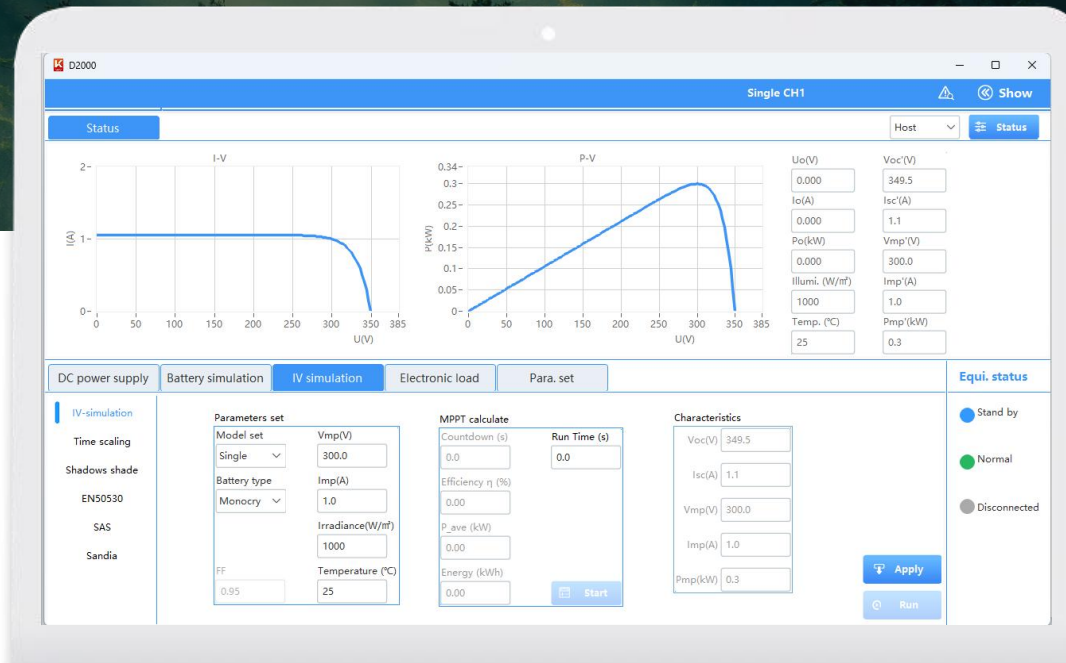

Curve editing



Multi-step simulation



Multi-step cycle

High Refresh Rate of IV Curves

Dynamic MPPT test, IV curve refresh interval as short as 100ms

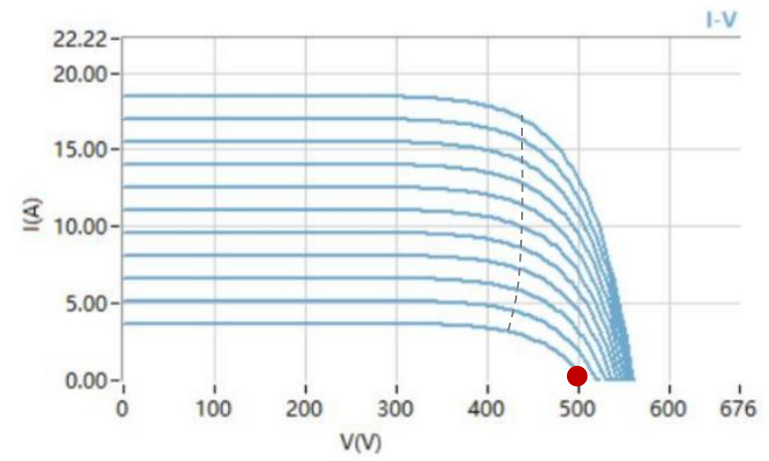

Typical Applications—IV Simulation

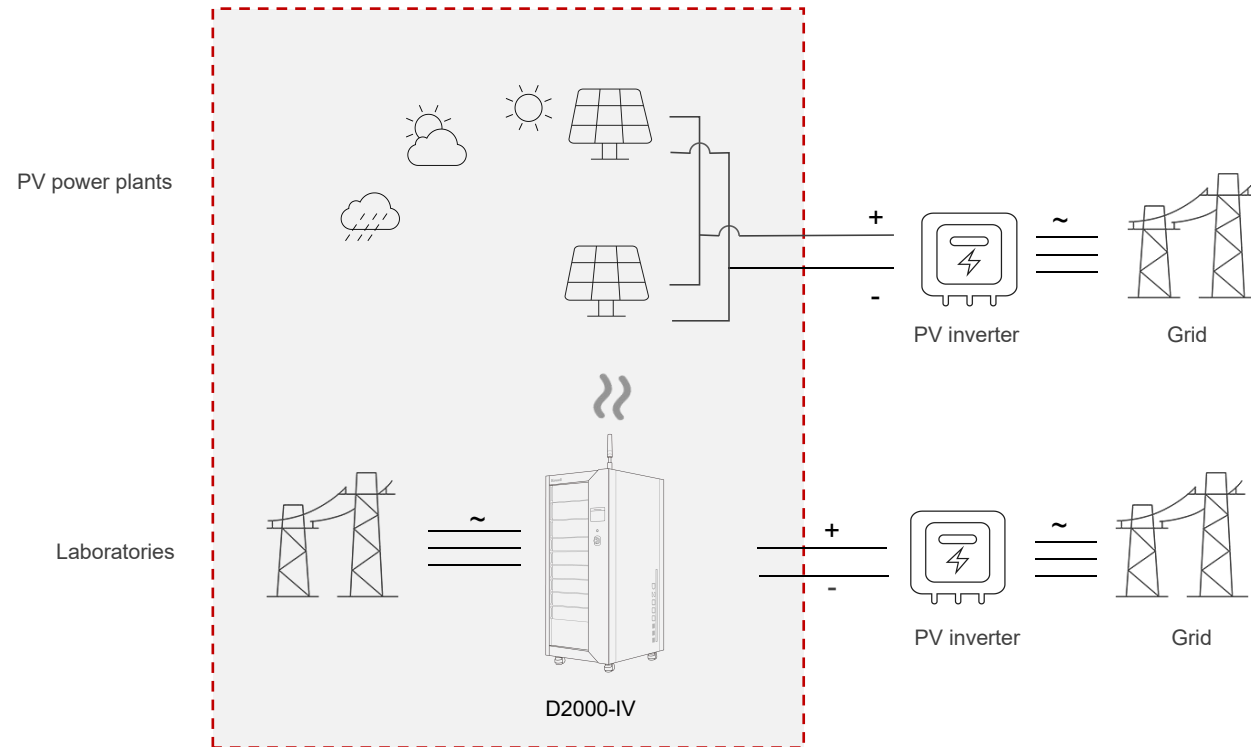

IV simulation function

1. The equipment can simulate the corresponding characteristics of monocrystalline, polycrystalline, and thin film solar panels;
2. Simulate the output of solar panels on sunny days, cloudy days, rainy days, etc.
3. Static MPPT test, simulate a single output characteristic of solar cells;
4. Dynamic MPPT test, simulate multiple output characteristics of solar cells.

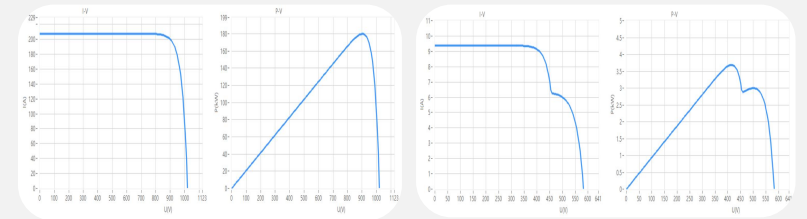

IV simulation

Shading

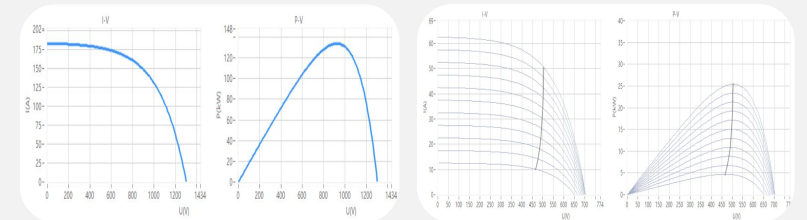

Static MPPT test

Dynamic MPPT test

Typical Applications—PCS Testing

MORE PRECISE AND CONVENIENT

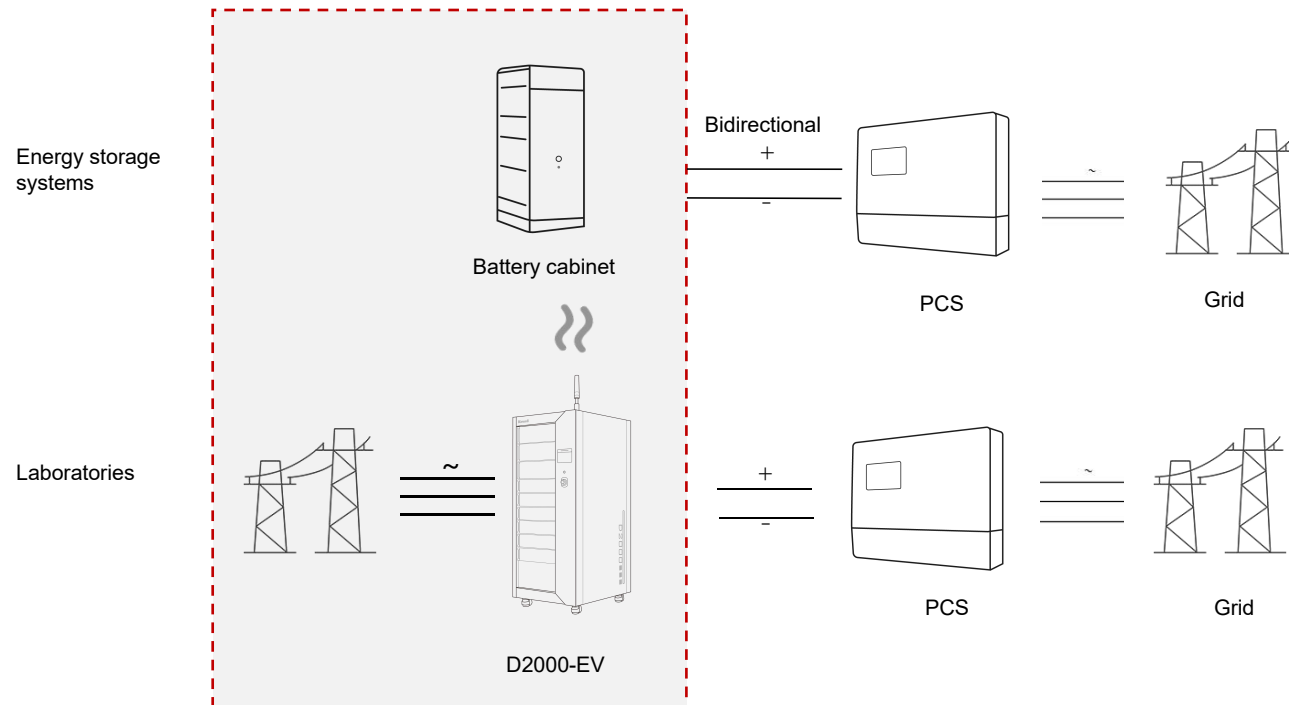

Battery simulation function

1. Able to simulate the output characteristics of lithium iron phosphate battery, a common type of energy storage battery;
2. Simulate battery charging process;
3. Simulate battery discharging process;
4. Simulate real batteries to run aging test for PCS.

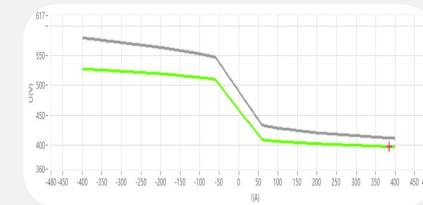

Fixed-type

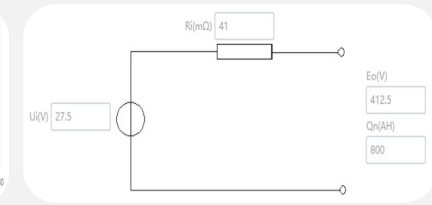

Custom type

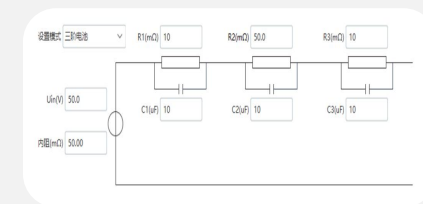

Third-order battery

Kewell

We are dedicated to becoming a global test equipment supplier covering versatile application industries based on test power supplies.

www.kewelltest.com